



---

1)		

---

---





---

---

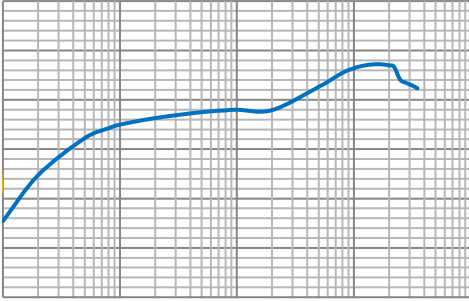
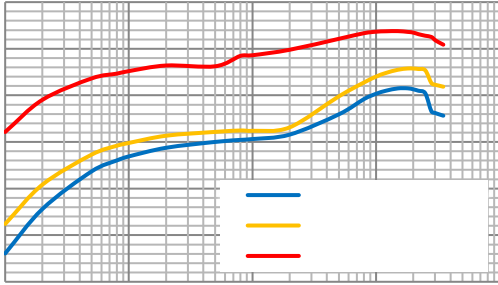
---

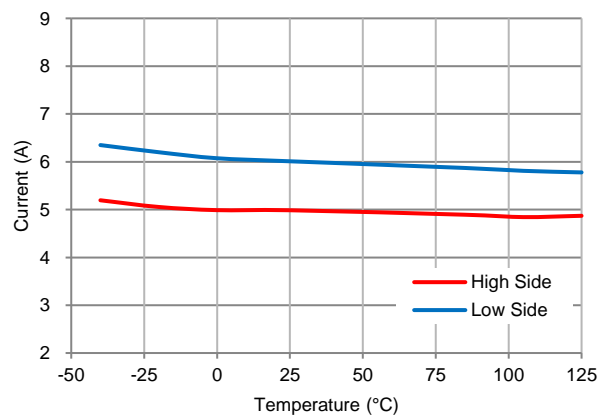
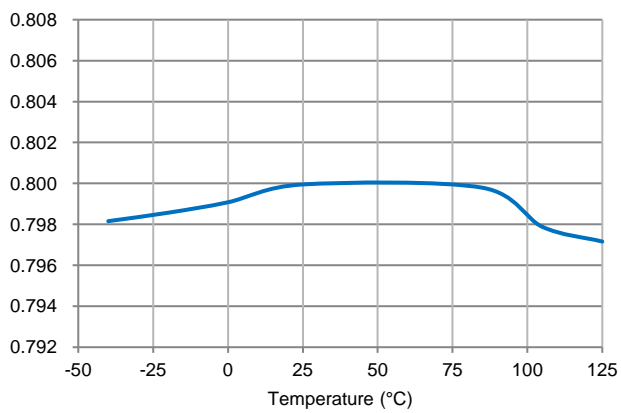
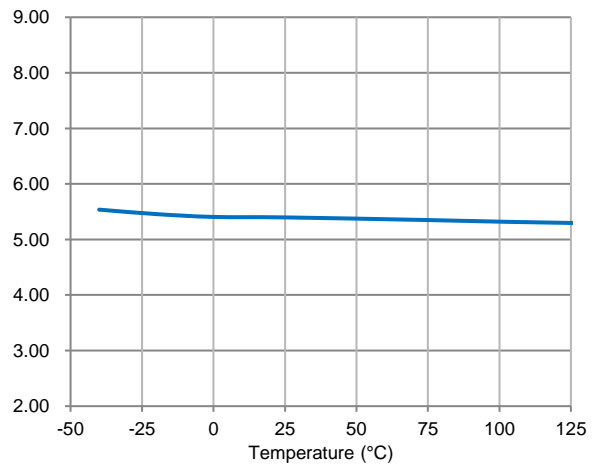
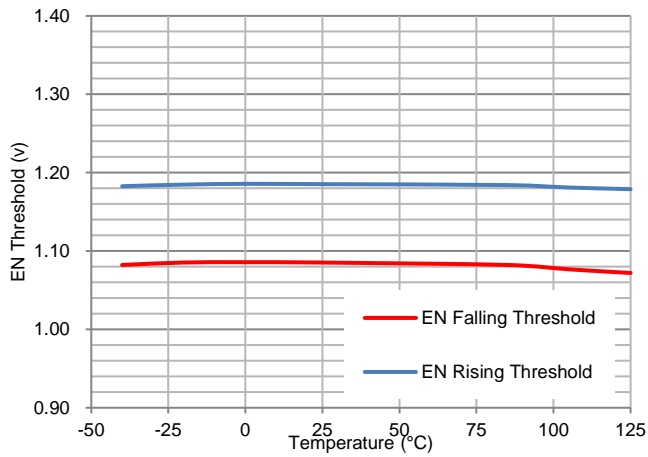
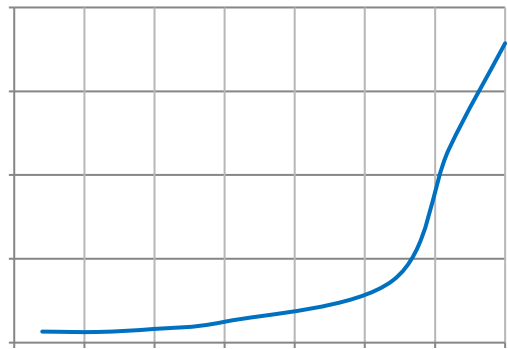
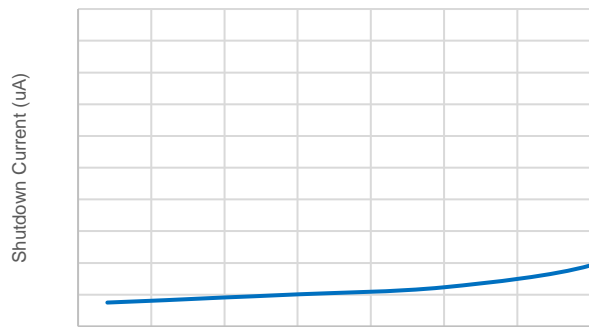

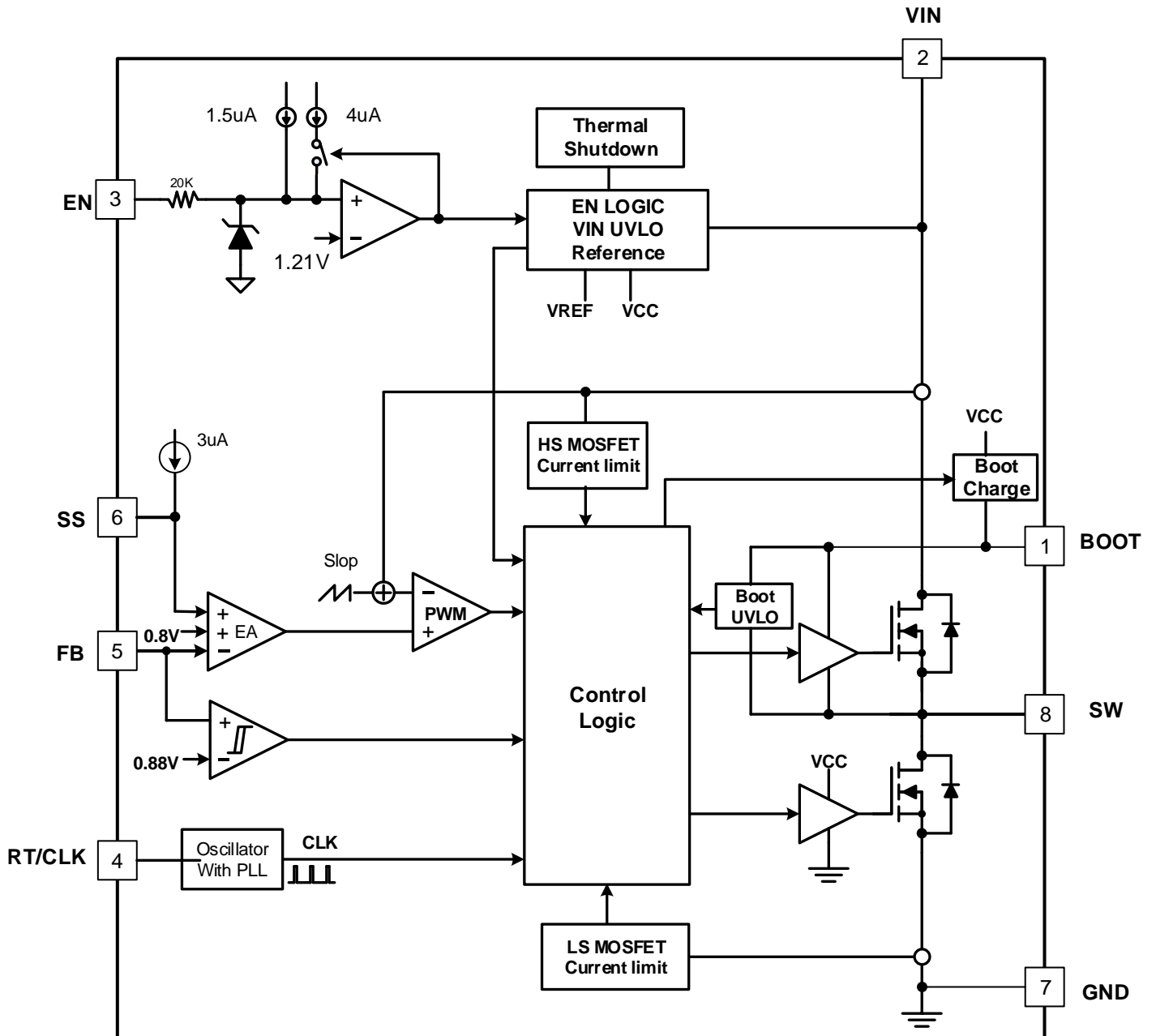







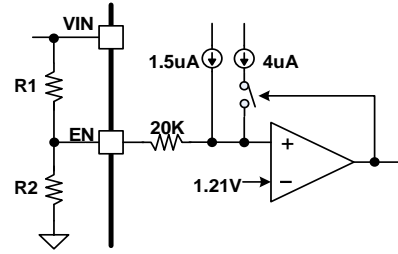

- 
- 

±

- 
- 

- 
-

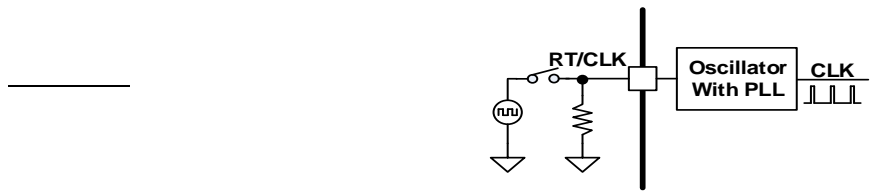



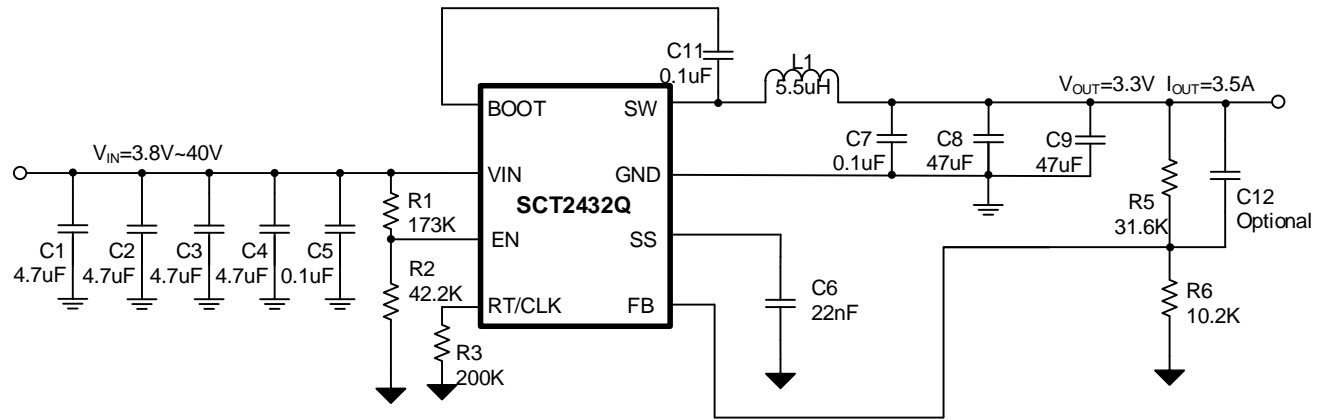



—

•

—

•

—

—

\_\_\_\_\_

- 
- 
- 
- 
- 

\_\_\_\_\_

- 
- 
- 
- 
- 
- 

\_\_\_\_\_

- 
- 
- 
-

---

- 
- - 
  - 
  - 
  -



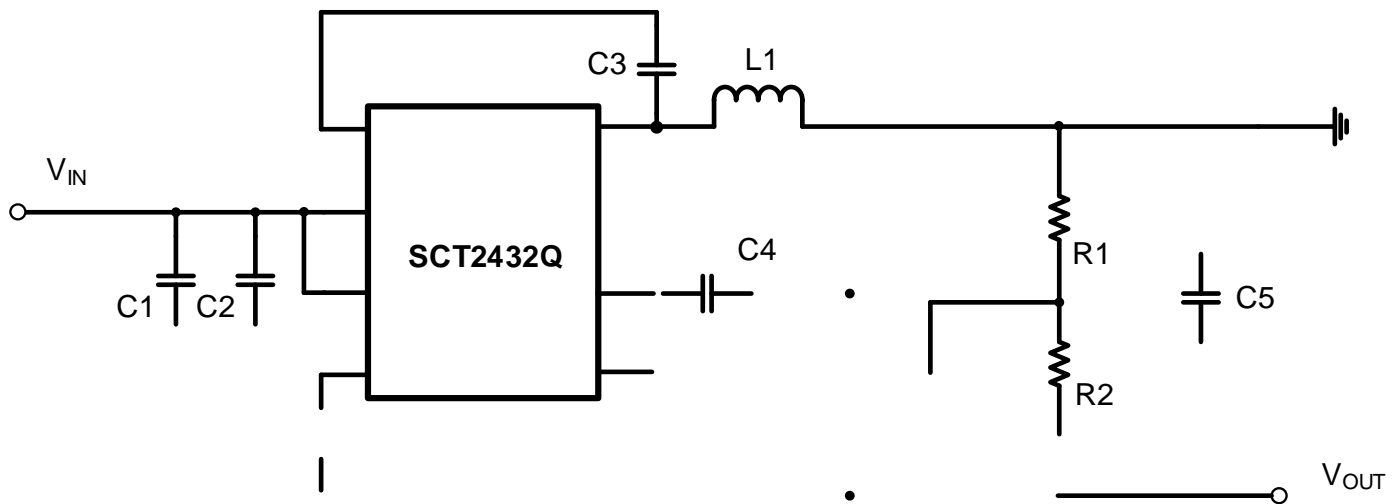

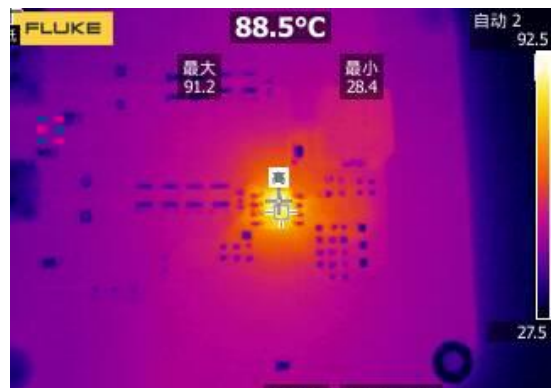
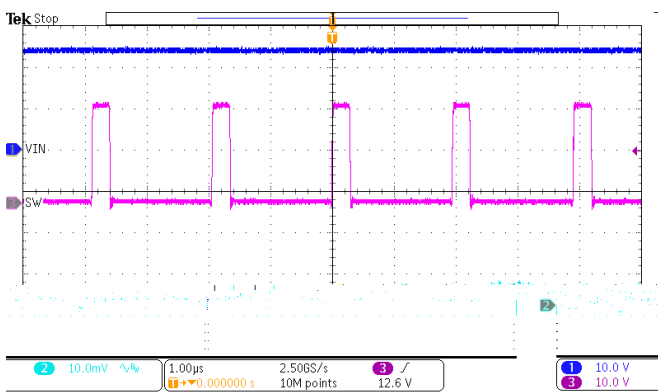
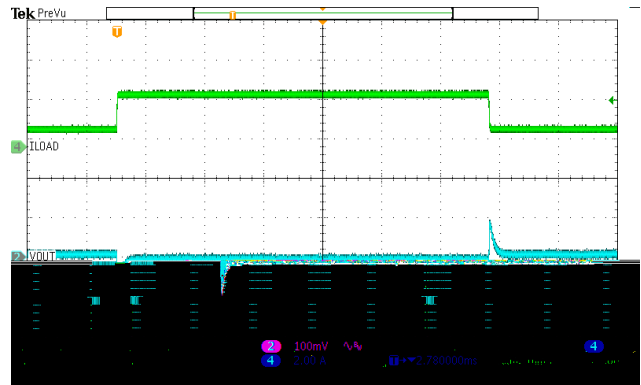
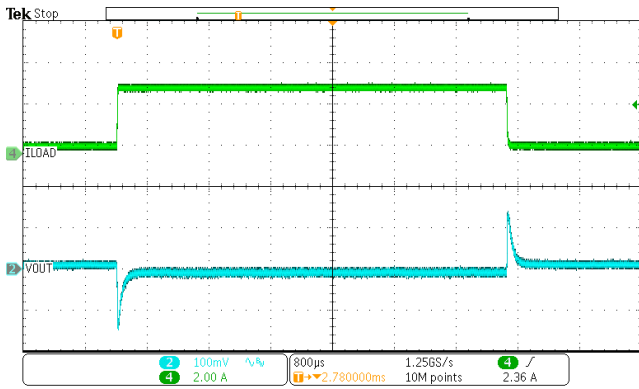
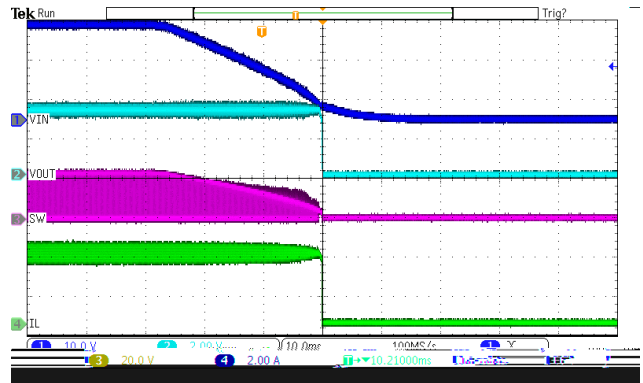
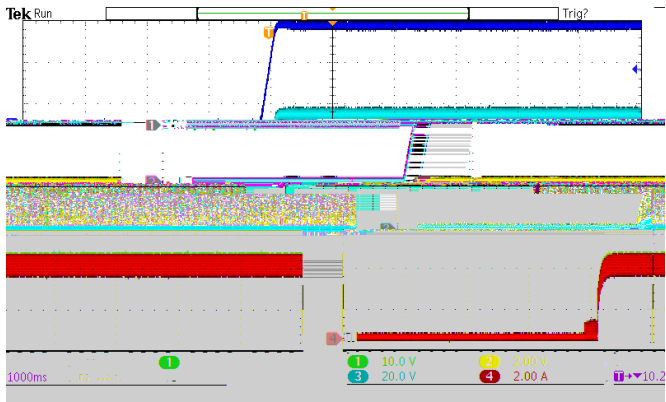

- 
- 1.
  - 2.
  - 3.
  - 4.
  - 5.
  - 6.
  - 7.
  - 8.
  - 9.
  - 10.

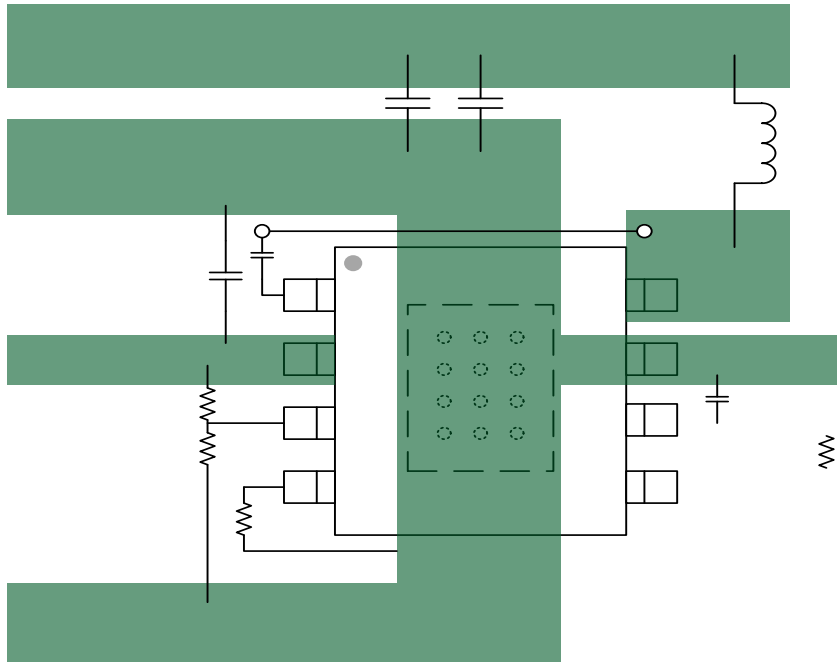



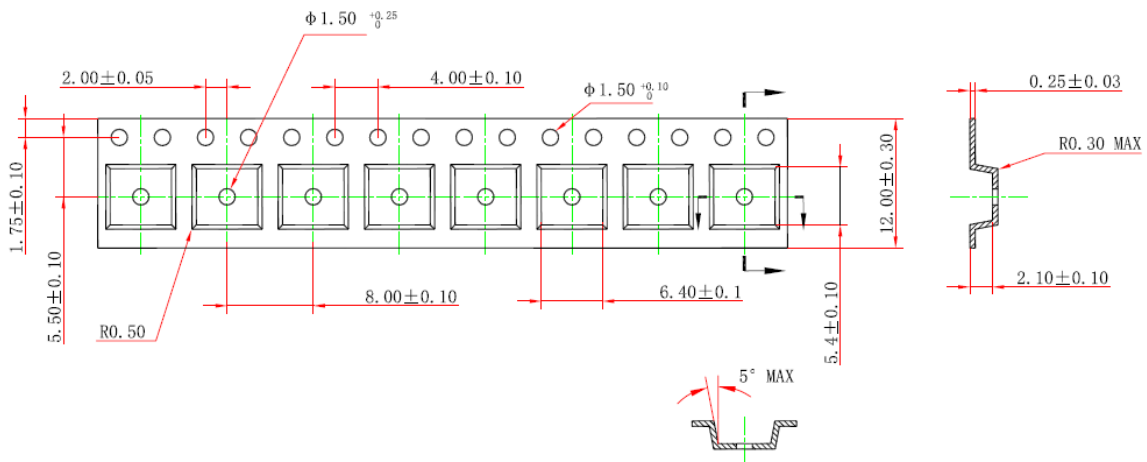
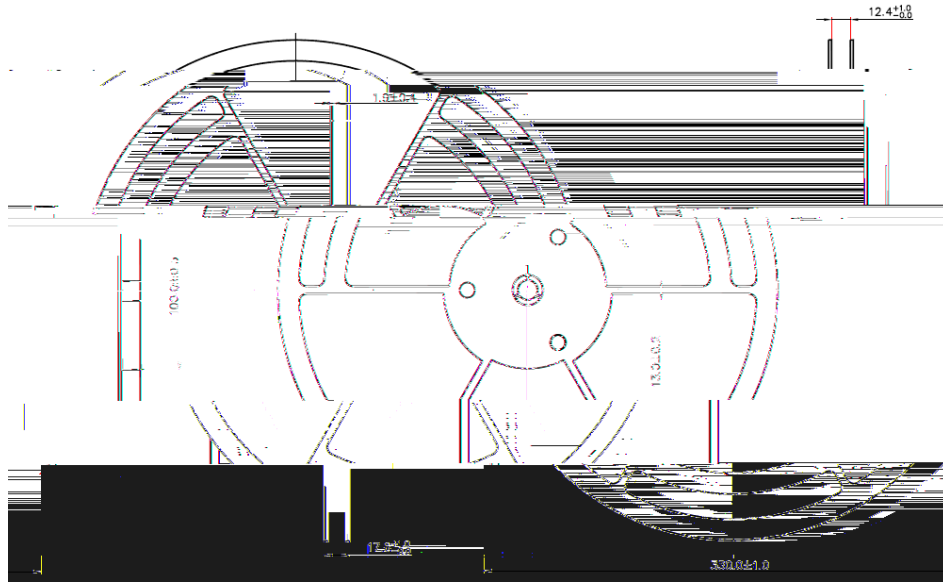

QUADRANT ASSIGNMENTS FOR PIN 1 ORIENTATION IN TAPE

